

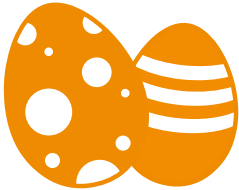

Mathematics 10-4-10 Above Expected Standard

Answer Booklet



**Easter
Revision**

DAY 1

Arithmetic Questions

1 $4.5 \div 100 =$

0.045

1 mark

2 $283 \times 34 =$

9622

2



3 $45.763 + 15.95 =$

$$\begin{array}{r} 45.763 \\ + 15.95 \\ \hline 61.713 \end{array}$$

61.713

1 mark

4 $5967 - \underline{\hspace{2cm}} = 239$

$$\begin{array}{r} 5967 \\ - 239 \\ \hline 5728 \end{array}$$

5728

1 mark

5 $\frac{2}{5} + \frac{6}{10} =$

$$\frac{2}{5} + \frac{6}{10} = \frac{4}{10} + \frac{6}{10} = \frac{10}{10}$$

$\frac{10}{10} = 1$

1 mark

DAY 1 – Reasoning Questions

1.

What is the smallest whole number that when rounded to the nearest 100 has an answer of 300?

250 (1 mark)

2.

Scott has -£16 in his bank account. Every week he gets paid £56 and he spends £63. How much will Scott have in his account after 2 weeks?

After 1 week: $-16 + 56 = 40$
 $40 - 63 = -£23$ -£30 (1 mark)

After 2 weeks: $-23 + 56 = £33$
 $£33 - £63 = -£30$

3.

7	0	2	9	1
---	---	---	---	---

Use four of these digit cards to make a four digit multiple of 10 that is less than 2000.

1970 (1 mark)
 OR 1270 or
 1790 or 1720

4.

What do the Roman Numerals CLXXV111 represent?

$100 + 50 + 20 + 5 + 3$ 178 (1 mark)

5.

This sequence of numbers goes up by 40 each time.

40 80 120 160 200 ...

This sequence continues.

Will the number 2140 be in the sequence?
 Circle Yes or No. Explain how you know.

$2140 \div 2 = 1070$
 $1070 \div 4 = 535$
 2140 divisible by 4
 but not by 40
 (doesn't end in 10)

(1 mark)

Arithmetic Questions

1 $6 \times 0.84 =$

5.04

1 mark

2 $1/8 \times 1/2 =$

$\frac{1}{8} \times \frac{1}{2} = \frac{1}{16}$

$1/16$

1 mark



3 $37400 + 481000 =$

$$\begin{array}{r} 37400 \\ + 481000 \\ \hline 518400 \end{array}$$

518,400

1 mark

4 $3567 \div 16 =$

$$\begin{array}{r} 16 \overline{) 3567} \\ \underline{32} \\ 48 \\ \underline{48} \\ 64 \\ \underline{64} \\ 80 \\ \underline{80} \\ 160 \\ \underline{160} \\ 0 \end{array}$$

222 r15

2

5 $8564 - \underline{\hspace{2cm}} = 2456$

$$\begin{array}{r} 8564 \\ - 2456 \\ \hline 6108 \end{array}$$

6,108

1 mark

DAY 2 – Reasoning Questions

1.

A box contains 330 matches and weighs 45 grams. The empty box weighs 12 grams. Calculate the weight of one match.

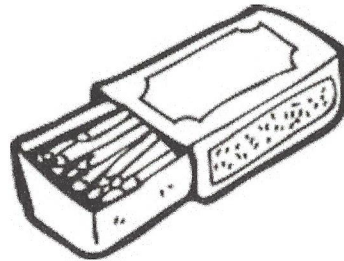

$$45 - 12 = 33 \text{ g}$$

$$33 \div 330 = 0.1$$

0.1 g (1 mark)

2.

Jimmy buys 2.64m of rope. Sally buys 76.4cm more rope than Jimmy. What is the length of Sally's rope in m?

$$2.64 \text{ m} = 264 \text{ cm}$$

3.404 m (1 mark)

$$\begin{array}{r} 264 \\ + 76.4 \\ \hline 340.4 \end{array}$$

$$340.4 \div 100 = 3.404 \text{ m}$$

3.

A swimming pool is filled with water at a rate of 13.592 litres every 150 seconds. Calculate the amount of water that goes into the pool in 12 minutes.

$$150 \text{ seconds} = 2\frac{1}{2} \text{ mins}$$

$$12 \div 2\frac{1}{2} = 24 \div 5 = 48 \div 10 = 4.8$$

65.2416 L (1 mark)

$$4.8 \times 13.592 = 65.2416$$

4.

Here is a map of part of France.

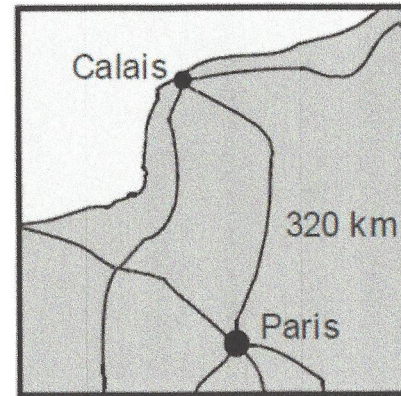

$$\begin{array}{r|l} \text{m} & \text{km} \\ \hline 5 & 8 \\ \hline \end{array} \quad \left. \begin{array}{l} \times 40 \\ \times 40 \end{array} \right\}$$

The map shows that the distance from Calais to Paris is 320 kilometres.

5 miles is approximately 8 kilometres.

Use these facts to calculate the approximate distance in miles from Calais to Paris.

$$5 \times 40 = 200$$

200 miles (1 mark)

5.

5 miles \approx 8 km. The distance between 2 cities is 565 miles. What is the distance in km?

$$\begin{array}{r|l} \text{m} & \text{km} \\ \hline 5 & 8 \\ \hline \end{array} \quad \times 113$$

904 km (1 mark)

$$565 \div 5 = 500 \div 5 + 65 \div 5 = 113$$

$$\begin{aligned} & 113 \times 8 \\ & = 100 \times 8 + 13 \times 8 \\ & = 800 + 104 \end{aligned}$$

DAY 3

Arithmetic Questions

1 7563 ÷ 26 =

				2	9	0	r	23		
26	1	2	6	7	5	6	3			
52	2			-	5	2				
78	3				2	3	6			
					2	3	4			
					2	3				
234	9				-	2	3			
260	10					0	290	r	23	

2

2 462067 + 9589 =

		4	6	2	0	6	7
+				9	5	8	9
		4	7	1	6	5	6

471,656

1 mark

3 95674 - 389.5 =

		9	5	⁵ 6	¹ 7	³ 4	.	0
-				3	8	9	.	5
		9	5	2	8	4	.	5

95284.5

1 mark

4 5/8 of 960 =

$\frac{1}{8}$ of 960 = 120
 $\frac{5}{8}$ of 960 = 120 x 5 = 600

600

1 mark

5 4.56 ÷ 1000 =

0.00456

1 mark



DAY 3 – Reasoning Questions

1.

Put these fractions in order, starting with the largest.

$$\frac{2}{3}, \frac{7}{12}, \frac{5}{6}, \frac{5}{8}$$

$$\frac{16}{24}, \frac{14}{24}, \frac{20}{24}, \frac{15}{24}$$

$$\frac{5}{6}, \frac{2}{3}, \frac{5}{8}, \frac{7}{12}$$

(1 mark)

2.

Tick (✓) any numbers that could be rounded to 17.6.

18.002 17.638 17.661 17.71 17.58

✓

✓

(1 mark)

3.

David saves 35% of his pocket money. He gets £4 each week.

How much does he save in 1 year?

$$35\% \text{ of } 100 = 35p$$

$$35\% \text{ of } 400 = 35 \times 4 = 140$$

$$\begin{array}{r} \times 140 \\ 52 \\ \hline 280 \\ 7000 \\ \hline 7280 \end{array}$$

£72.80 (1 mark)

4. A school canteen stocks five flavours of crisps. $\frac{2}{5}$ are salt and vinegar, $\frac{1}{8}$ are cheese and onion, $\frac{1}{4}$ are prawn cocktail, $\frac{1}{5}$ are ready salted and the rest are chicken flavour. The canteen has 60 bags of crisps. Is this correct?

Circle Yes or (No) Explain your answer.

$\frac{2}{5}$ of 60 = 24

$\frac{1}{8}$ of 60 = 7.5

not whole number
so cannot be 60
bags of crisps

(1 mark)

5.

Emily makes 250 grams of a snack mixture. 15% of the weight is raisings, 25% is banana chips and the rest is peanuts.

How many grams of peanuts does she use?

$$15 + 25 = 40$$

$$100 - 40 = 60\%$$

$$60\% \text{ of } 250 = 25 \times 6 = 150$$

150g (1 mark)

Arithmetic Questions

1 $3.45 \times \underline{\hspace{2cm}} = 34500$

10,000

1 mark

2 $7^2 + 5^3 = 208 - \underline{\hspace{2cm}}$

$49 + 125 = 174$

$208 - 174 = 34$

34

1 mark



3 $245.76 + 48.9 =$

			2	4	5	.	7	6	
				4	8	.	9	0	
			2	9	4	.	6	6	
				'	'				

294.66

1 mark

4 $\frac{3}{4} - \frac{4}{9} =$

$\frac{3}{4} - \frac{4}{9} = \frac{27}{36} - \frac{16}{36} = \frac{11}{36}$

$\frac{11}{36}$

1 mark

5 $5867 \div 34 =$

	34	1					1	7	2	r 19
	68	2		34	5867					
	102	3			-	34				
	136	4				<u>246</u>				
	170	5				-	238			
	204	6					<u>8</u>			
	238	7					-	88		
								<u>19</u>		

172 r 19

2

DAY 4 – Reasoning Questions

1.

Here are four statements.

For each statement put a tick (✓) if it is possible.
Put a cross (✗) if it is impossible.

- A triangle can have 2 acute angles.
- A triangle can have 2 obtuse angles.
- A triangle can have 2 parallel sides.
- A triangle can have 2 perpendicular sides.

2. Find the size of angle a. (1 mark)

42° (1 mark)

3.

ABCD is a rectangle drawn on coordinate axes.
The sides of the rectangle are parallel to the axes.

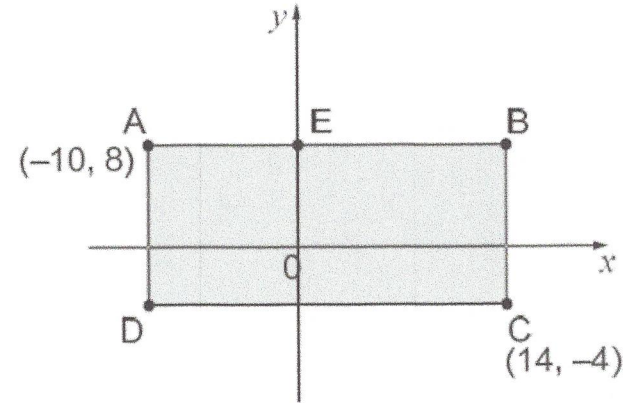

What are the coordinates of D and E?

D(-10, -4) E(0, 8) (1 mark)

4.

Here is a triangle on a square grid. The triangle is translated so that point A moves to point B.

Draw the triangle in its new position. Use a ruler.

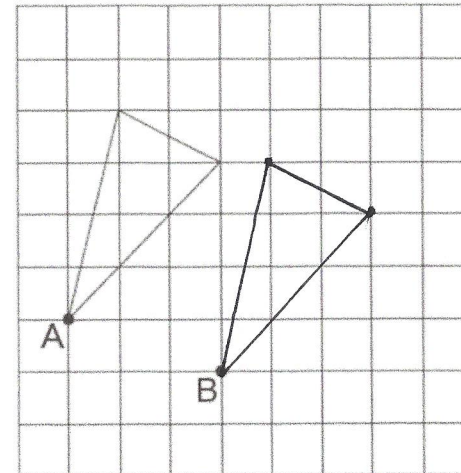

(1 mark)

Arithmetic Questions

1 $480 \div 0.6 =$

$480 \div 6 = 80$

$480 \div 0.6 = 800$

800

1 mark

2 $-23 + 12 =$

-11

1 mark



3 $4\frac{4}{7} - 1\frac{1}{3} =$

$4\frac{4}{7} - 1\frac{1}{3} = 3\frac{5}{21}$

$\frac{4}{7} - \frac{1}{3} = \frac{12}{21} - \frac{7}{21} = \frac{5}{21}$

$3\frac{5}{21}$

1 mark

4 42% of £13 =

10% of £13 = £1.30

40% of £13 = £5.20

1% of £13 = £0.13

2% of £13 = £0.26

£5.20 + £0.13 = £5.46

1 mark

5 $6295 \times 17 =$

$$\begin{array}{r} 6295 \\ \times 17 \\ \hline 44065 \\ + 62950 \\ \hline 107015 \end{array}$$

107,015

2

DAY 5 – Reasoning Questions

1. Here is a recipe for cupcakes.

How many cakes have you made

if you have used 450ml of milk?

$$450 \div 90 = 5$$

$$5 \times 12 = 60$$

Cupcakes (makes 12)
210g flour
160g butter
150g sugar
90ml milk

60 cakes (1 mark)

2. Mr Smith has a large box of fruit. For every apple in the box there are 3 bananas and 2 kiwis. Mr Smith has 54 pieces of fruit in total. How many of each fruit does he have?

9 apples 27 bananas 18 kiwis

1 : 3 : 2 $54 \div 6 = 9$ (1 mark)

check: $9 + 27 + 18 = 54$ ✓

3.

The distance from A to B is three times as far as from B to C.

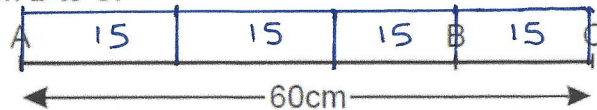

$$60 \div 4 = 15$$

$$60 - 15 = 45$$

The distance from A to C is 60 centimetres.
Calculate the distance from A to B.

45 cm (1 mark)

4.

Here is a sequence of patterns made from squares and circles.

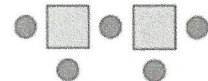
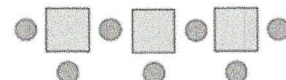
	Number of squares	Number of circles
	1	3
	2	5
	3	7

The sequence continues in the same way.
Calculate how many squares there will be in the pattern which has 25 circles.

$$25 - 1 = 24$$

$$24 \div 2 = 12$$

12 (1 mark)

5.

The prices of some orders from a newsagent are shown below:

1 chocolate bar and 1 magazine cost £6

3 chocolate bars and 4 cans cost £16

1 magazine and 3 cans cost £5

How much will it cost in total to buy 5 of each item?

chocolate £4.00
magazine £2.00
cans £1.00

(1 mark)

DAY 6

Arithmetic Questions

1 $4500 \div \underline{\hspace{2cm}} = 4.5$

1000

1 mark

2 $0.27 \times 8 =$

$$\begin{array}{r} 27 \\ \times 8 \\ \hline 216 \end{array}$$

2.16

1 mark



3 $3/8 \div 5 =$

$$\frac{3}{8} \div 5 = \frac{3}{8} \times \frac{1}{5}$$

$$= \frac{3}{40}$$

$\frac{3}{40}$

1 mark

4 $576.3 - 34.99 =$

$$\begin{array}{r} 576.30 \\ - 34.99 \\ \hline 541.31 \end{array}$$

541.31

1 mark

5 $1\frac{1}{4} + \frac{5}{6} =$

$$1\frac{1}{4} + \frac{5}{6} = 1 + 1\frac{1}{12} = 2\frac{1}{12}$$

$$\frac{1}{4} + \frac{5}{6} = \frac{3}{12} + \frac{10}{12} = 1\frac{1}{12}$$

$2\frac{1}{12}$

1 mark

DAY 6 – Reasoning Questions

1.

This chart shows the number of books some children read last month

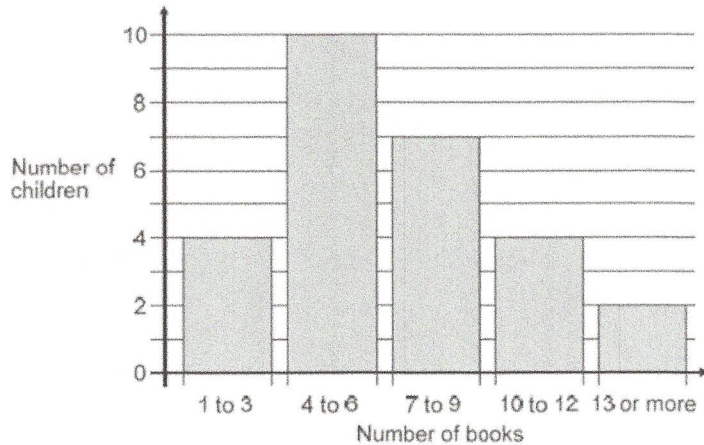

How many children altogether read more than 9 books?

6 (1 mark)

7 children read 4 books. 1 child read 5 books. Lin says, 'That means 2 children read 6 books.'
Explain how she can work this out from the chart.

4 - 6 books — 10 children
7 read 4 bks, 1 child read 5 bks
 $7 + 1 = 8$
 $10 - 8 = 2$ children who read 6 books

(1 mark)

2.

This pie chart shows how the 32 children in Class 6 best like their potatoes cooked.

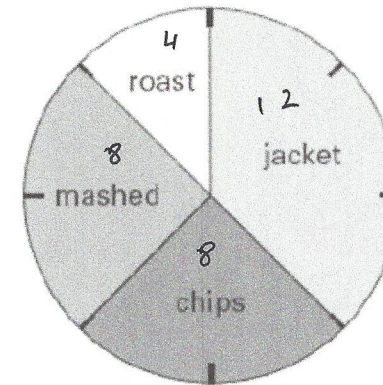

Look at the four statements below.
For each statement put a tick (✓) if it is correct.
Put a cross (×) if it is not correct.

10 children like chips best.

25% of the children like mashed potatoes best.

$\frac{1}{5}$ of the children like roast potatoes best.

12 children like jacket potatoes best.

(1 mark)

DAY 7

Arithmetic Questions

1 $(18 \div 3) + 5 \times 4 =$

$$6 + 20$$

26

1 mark

2 $45.6 \div 100 =$

0.456

1 mark



3 $8674 \div 15 =$

						5	7	8	r	4
15	1				1	5	8	6	7	4
30	2				-	7	5	↓		
45	3					1	1	7		
60	4				-	1	0	5	↓	
75	5						1	2	4	
90	6				-	1	2	0		
105	7								4	578 r4
120	8									

2

4 $8^2 - 3^3 =$

$$64 - 27$$

37

1 mark

5 $\frac{2}{5} \div 4 =$

$$\frac{2}{5} \div 4 = \frac{2}{5} \times \frac{1}{4} = \frac{2}{20} = \frac{1}{10}$$

$\frac{1}{10}$

1 mark

DAY 7 – Reasoning Questions

1.

Here is a rectangle with a width of 15.7 centimetres.

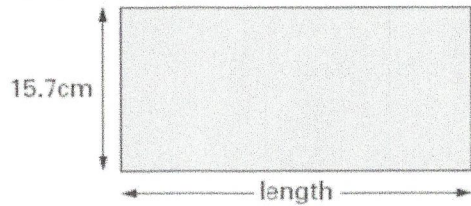

Not actual size

$$\begin{array}{r} 15.7 \\ + 15.7 \\ \hline 31.4 \\ - 85.0 \\ \hline 53.6 \end{array}$$

The perimeter of this rectangle is 85 centimetres.

Calculate the length of the rectangle.

$$53.6 \div 2 = 50 \div 2 + 3.6 \div 2$$

$$= 25 + 1.8 = 26.8 \quad \underline{26.8} \text{ (1 mark)}$$

2. A square has four sides. One of its sides measures 67mm.

Work out its area and perimeter in cm.

Area = 44.89 cm² 6.7×6.7

Perimeter = 26.8 cm $6.7 \times 4 = 26.8$ (2 marks)

3.

Steven started his bike ride at 9:42am. He cycled for 76 minutes, then stopped for 240 seconds before finishing exactly one hour later. What time did Steven finish his bike ride?

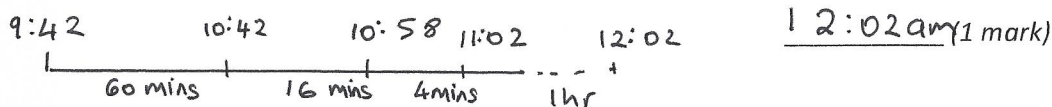

4.

This is a centimetre grid.

Draw 3 more lines to make a parallelogram with an area of 10 cm².

Use a ruler.

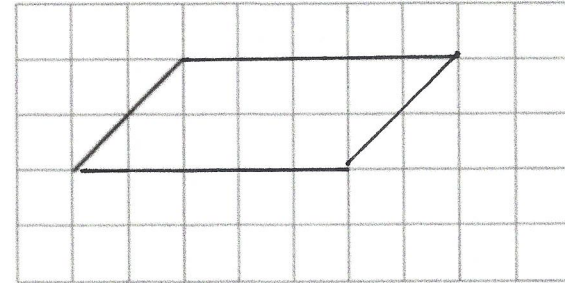

(1 mark)

5.

Amit has some small cubes.

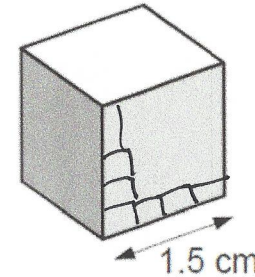

$$6^3 = 216$$

Larger cube = $6 \text{ cm} \times 6 \text{ cm} \times 6 \text{ cm}$

$$6 \div 1.5 = 4$$

$$4 \times 4 \times 4 = 64$$

The edge of each cube is 1.5 centimetres.

He makes a larger cube out of the small cubes.

The volume of this larger cube is 216 cm³.

How many small cubes does he use?

64 (1 mark)

DAY 8 – Reasoning Questions

1.

250 000 people visited a theme park in one year. 15% of the people visited in April and 40% of the people visited in August. How many people visited the park in the rest of the year?

$$40\% + 15\% = 55\%$$

$$55\% \text{ of } 250,000 = 137,500$$

$$250,000 - 137,500 = 112,500 \quad (1 \text{ mark})$$

2.

There are 24 coloured cubes in a box. Three-quarters of the cubes are red, four of the cubes are blue and the rest are green.

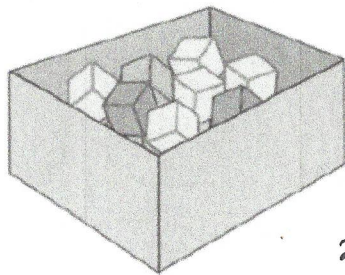

$$\frac{3}{4} \text{ of } 24 = 18$$

$$\text{red} = 18$$

$$\text{blue} = 4$$

$$18 + 4 = 22$$

$$24 - 22 = 2$$

How many green cubes are in the box? 2 (1 mark)

One more blue cube is put into the box. What fraction of the cubes in the box are blue now?

$$\frac{5}{25} = \frac{1}{5}$$

$$\frac{1}{5} \quad (1 \text{ mark})$$

3.

I pay £16.00 to travel to work each week. I work for 45 weeks each year. How much do I pay to travel to work each year? Show your working.

$$\begin{array}{r} 16 \\ \times 45 \\ \hline 80 \\ 640 \\ \hline 720 \end{array}$$

$$\begin{array}{r} 14 \\ \hline 45 \overline{) 630} \\ \underline{- 45} \\ 180 \\ \underline{- 180} \\ 0 \end{array}$$

£720 (1 mark)

I could buy one season ticket that would let me travel for all 45 weeks. It would cost £630. How much is that per week? £14 (1 mark)

$$630 \div 45 = 14$$

4.

Write in the missing numbers.

$$813.75 \div \square = 21.7 = 37.5$$

$$100 - (22.75 + 19.08) = \square 58.17 \quad (1 \text{ mark})$$

5.

The diagram shows three regular octagons joined together. There is a dot at the centre of each one.

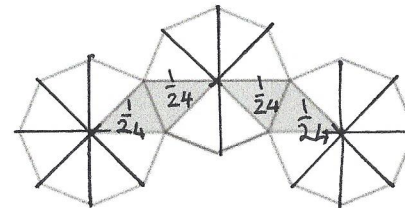

$$\frac{4}{24} = \frac{1}{6}$$

What fraction of the diagram is shaded? $\frac{1}{6}$ (1 mark)

Arithmetic Questions

1 $6 \times 5 - 45 \div 5$

$30 - 9$

21

1 mark

2 $\frac{1}{4} \times \frac{1}{6} =$

$\frac{1}{4} \times \frac{1}{6}$

$\frac{1}{24}$

1 mark



3 $578300 - 200 =$

$578,100$

1 mark

4 $7454 \times 26 =$

			7	4	5	4		
					2	6		
			x					
			4	4	7	2	4	
			1	4	9	0	8	0
			1	9	3	8	0	4

$193,804$

2

5 $\frac{7}{9} + \frac{5}{8} =$

$\frac{7}{9} + \frac{5}{8} = \frac{56}{72} + \frac{45}{72}$

$= \frac{101}{72} = 1 \frac{29}{72}$

$\frac{101}{72}$ or $1 \frac{29}{72}$

1 mark

DAY 9 – Reasoning Questions

1.

Find two square numbers that total 45.

$$\boxed{9} + \boxed{36} = 45$$

(1 mark)

2.

Write all the factors of 30 which are also factors of 20.

1, 2, 5, 10

(1 mark)

3.

Two whole numbers are each between 60 and 70. They multiply to make 4095.

Write in the missing numbers.

65 × 61 or 65 × 63 or 65 × 65

$$\begin{array}{r} \times 65 \\ 63 \\ \hline 195 \\ 3900 \\ \hline 4095 \end{array}$$

$$\square \times \square = 4095$$

$$\underline{65 \times 63} \quad (1 \text{ mark})$$

4.

Here are five number cards.

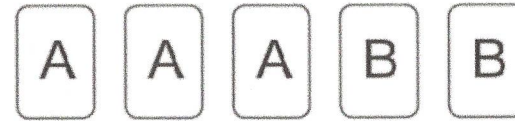

A and B stand for two different whole numbers.

The sum of all the numbers on all five cards is 30.

What could be the values of A and B?

$$A = 2 \quad B = 12$$

$$A = 4 \quad B = 9$$

$$A = 6 \quad B = 6 \quad \times$$

$$A = 8 \quad B = 3$$

$$A = 10 \quad B = X$$

$$A = 2 \quad B = 12$$

$$\text{or } A = 4 \quad B = 9 \quad (1 \text{ mark})$$

$$\text{or } A = 8 \quad B = 3$$

5.

Ben thinks of a number.

He adds half of the number to a quarter of the number. The result is 60.

What was the number Ben first thought of?

Show your working.

$$\frac{1}{2} \text{ of } \square + \frac{1}{4} \text{ of } \square = \frac{3}{4} \text{ of } \square \quad \underline{80} \quad (1 \text{ mark})$$

$$\frac{3}{4} \text{ of } \square = 60$$

$$\frac{1}{4} \text{ of } \square = 20$$

$$\frac{4}{4} \text{ of } \square = 20 \times 4 = 80$$

Arithmetic Questions

1 $1/12 \times 1/3 =$

$$\frac{1}{36}$$

2 $0.07 \times 12 =$

$$0.84$$



3 36% of 3400

$$10\% \text{ is } 340 +$$

$$20\% \text{ is } 680$$

$$30\% \text{ is } \underline{1020}$$

$$1\% \text{ is } 34$$

$$5\% \text{ is } \underline{170}$$

$$\underline{204}$$

$$\begin{array}{r} 1020 \\ + 204 \\ \hline 1224 \end{array}$$

$$1224$$

4 $56429 - 14834$

$$\begin{array}{r} 56429 \\ - 14834 \\ \hline 41595 \end{array}$$

$$41,595$$

5 $1/6 \div 8 =$

$$\frac{1}{6} \div 8 = \frac{1}{6} \times \frac{1}{8}$$

$$= \frac{1}{48}$$

$$\frac{1}{48}$$

DAY 10 – Reasoning Questions

1. A circle has a diameter of 136cm. What is the length of its radius? $136 \div 2$ 68 (1 mark)

2. The radius of one circle is 8.5cm. All the circles are the same size.

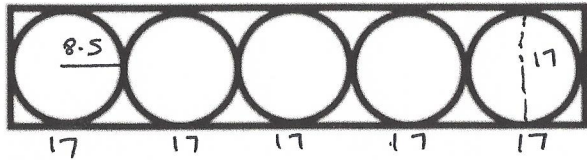

$$17 \times 5 = 85$$

What are the dimensions of the rectangle?

Length 85 cm width 17 cm (1 mark)

3.

This diagram is not drawn accurately. Calculate the size of angle m .

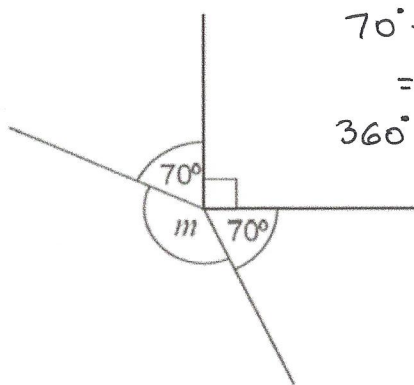

$$\begin{aligned} 70^\circ + 70^\circ + 90^\circ \\ = 230^\circ \\ 360^\circ - 230^\circ = 130^\circ \end{aligned}$$

130° (1 mark)

3.

The pie charts show the results of a school's netball and football matches.

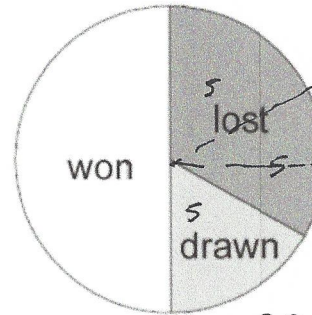

Netball 30

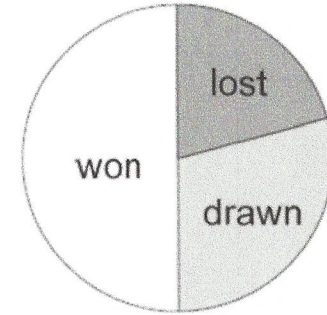

Football 24

The netball team played 30 games.

The football team played 24 games.

Estimate the percentage of games that the netball team lost. 10 (1 mark)

David says, 'The two teams won the same number of games'.

Is he correct? Circle Yes or No.

Explain how you know.

Netball won $\frac{1}{2}$ of 30 games = 15
Football won $\frac{1}{2}$ of 24 games = 12

(1 mark)